



)

(

"

"

"

"







q >

μ

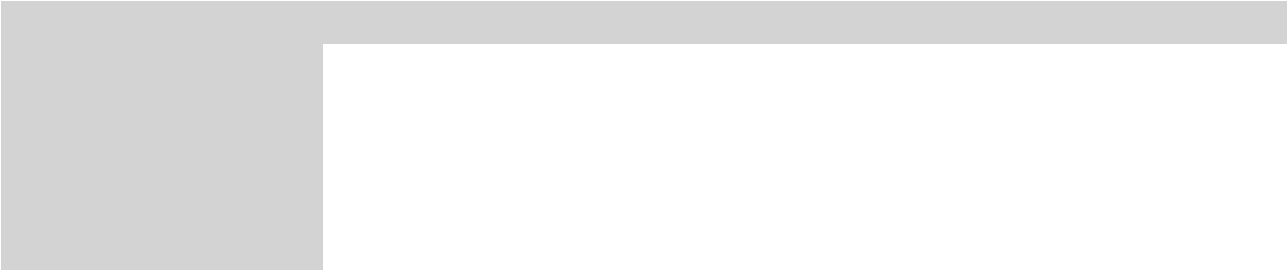

1 --

1 --





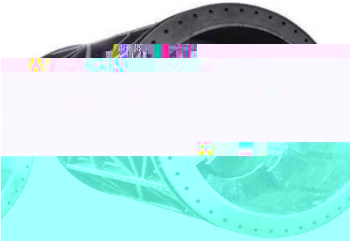
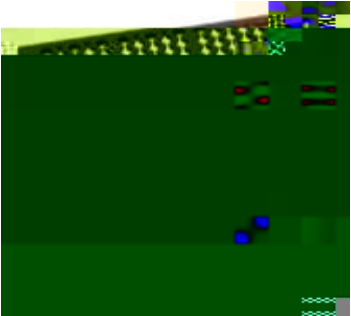

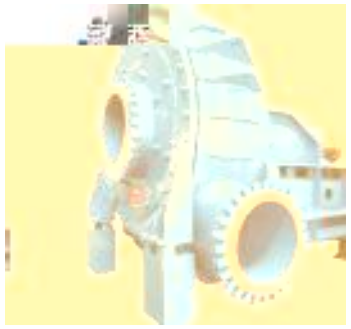
" "

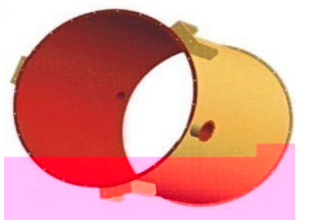



3

3









10%

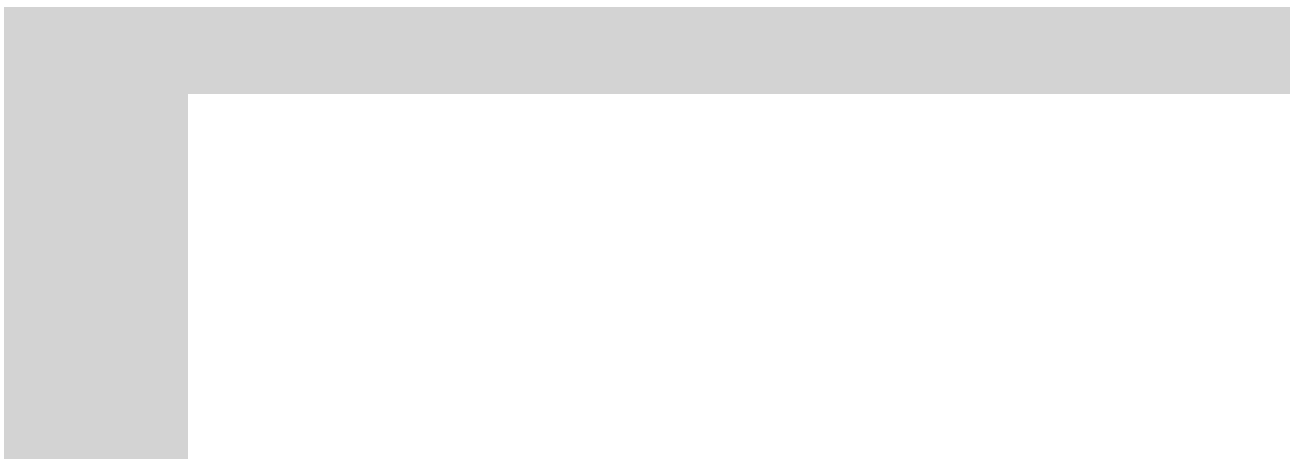



1

1

483 35

8 (c°?UT€

2

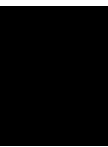
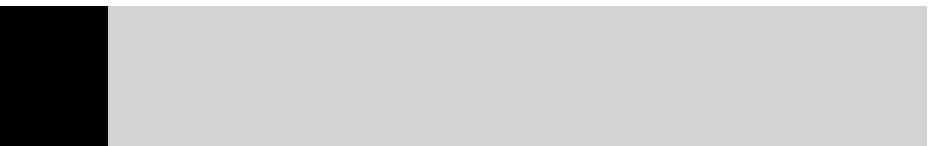

//

//

38

2

3

1

2



~~Handwritten scribbles and symbols at the top of the page, including a large 'S' on the right and various overlapping lines and shapes.~~

□

o

" "

S



1

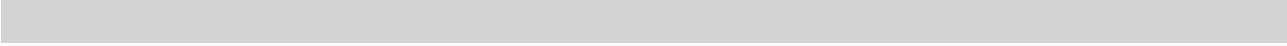

1

ž ž ž ž

Z Ô! 0 è0 >|

И з СЗ .# 0 È! È< 0 È " p

3

γC| v 0 1801A. 0< E B 0

!γC| €#7 È 0 0





X

&

É

--	--	--	--	--	--	--	--	--

4

" "

							()	

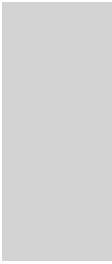

1



K O

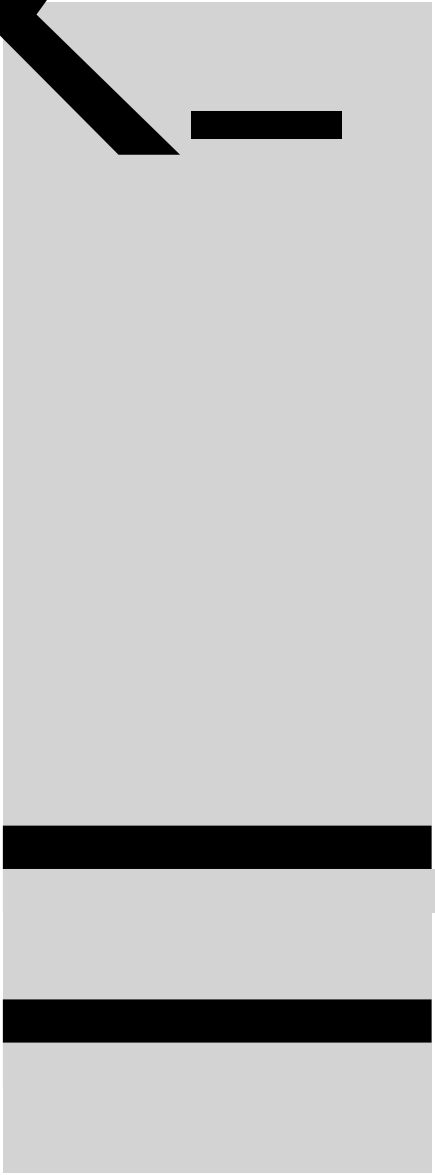

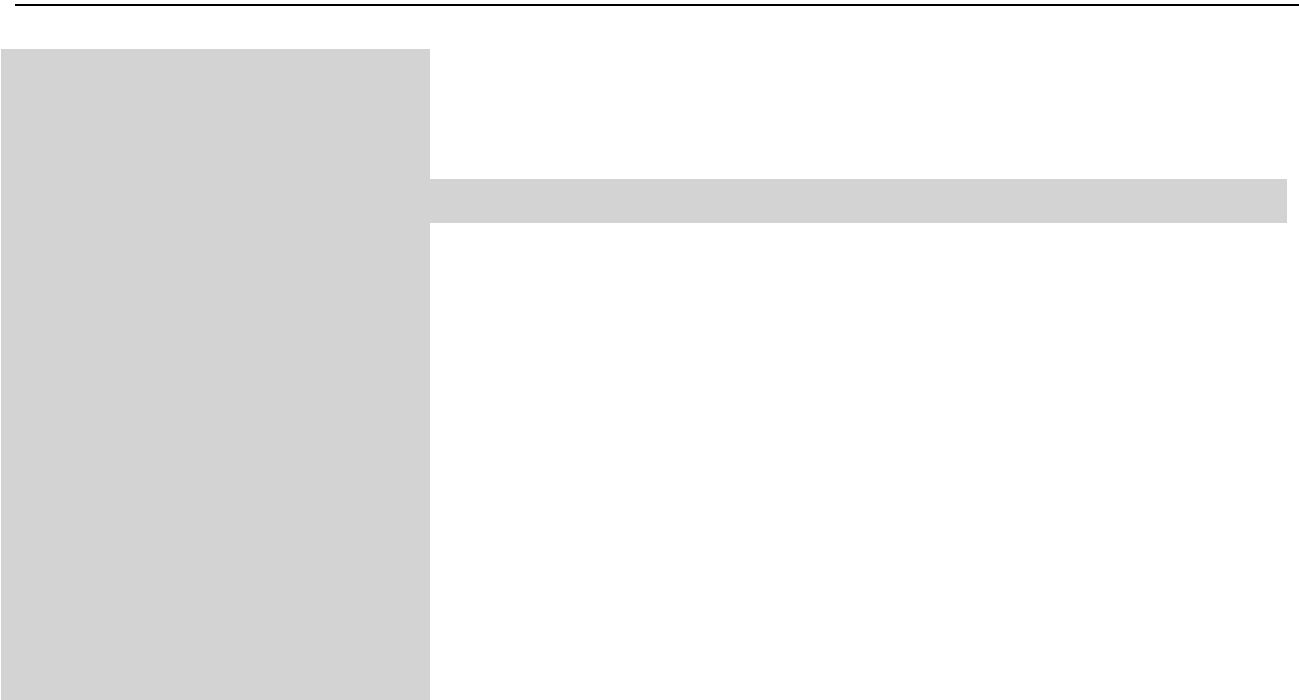

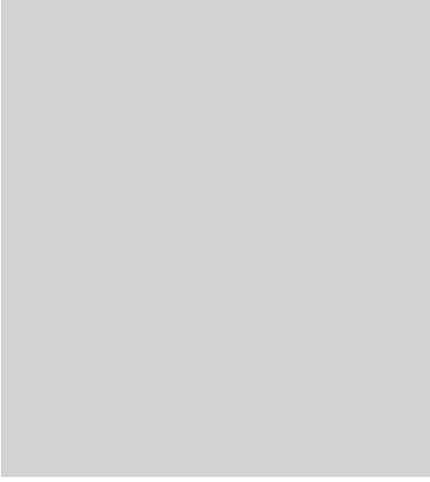

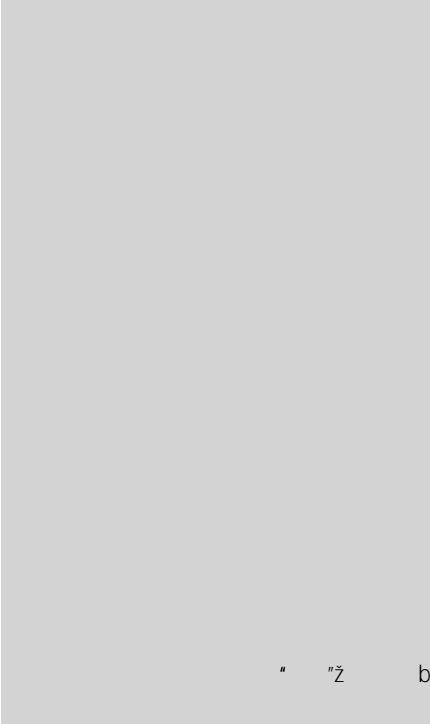

" "ž b

g " g " g " g "

g " g "

1.

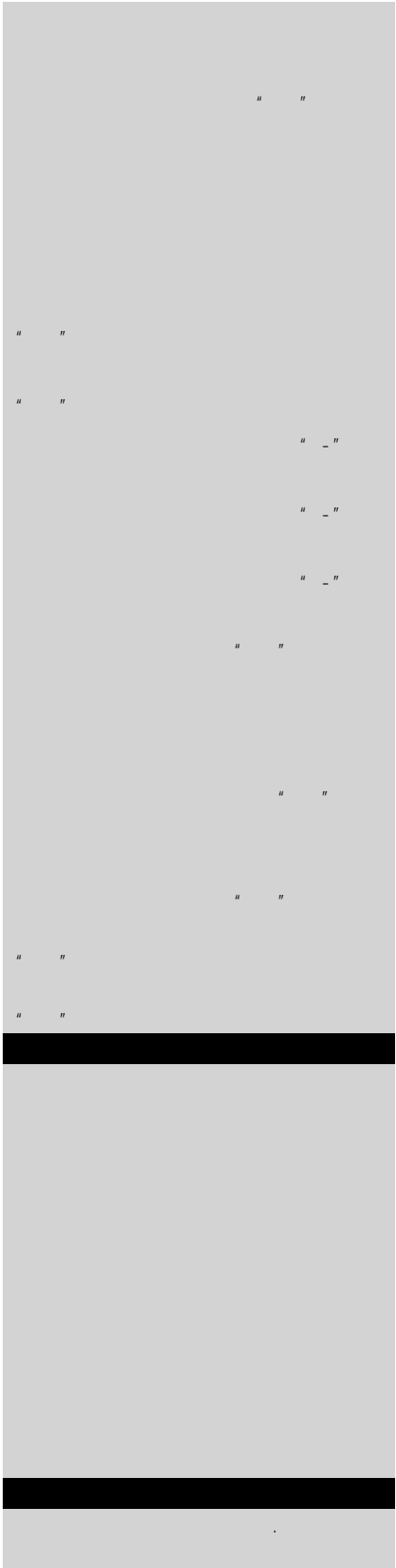

ΑΥΤΟ ΤΟ ΠΡΟΤΥΠΟ ΕΧΕΙ ΚΑΤΑΣΤΑΣΗ ΕΛΕΥΘΕΡΗΣ ΧΡΗΣΗΣ ΚΑΙ ΔΕΝ ΑΠΑΙΤΕΙ ΤΙΣ ΕΠΙΧΕΙΡΗΣΙΑΚΕΣ ΠΡΟΒΛΕΨΕΙΣ ΤΗΣ ΕΤΕΡΗΣ ΟΜΑΔΑΣ



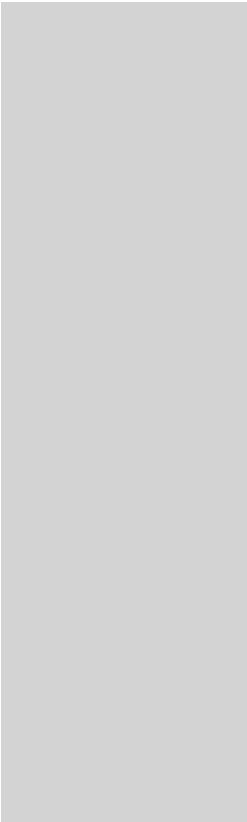

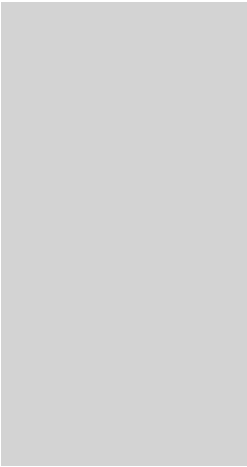







" "

4

5

1.

1

2

3

4

2

S

D

i i i

1

2

1

B.

C.

D.

3

4

7

1.

1

2

3

2

1

2

3

4

5

8

8

8

9

1.

2

" "

10

)

(

)

(

1.

1

2

3

1

1

2

5

1

2

2

1

1

2

2

1

2

3

1

3.

1

1

2

Ä

1

2

3

1 2

1

2

1

1

2

1

2

3

4

5

2

1

2

3

4

5

6

3

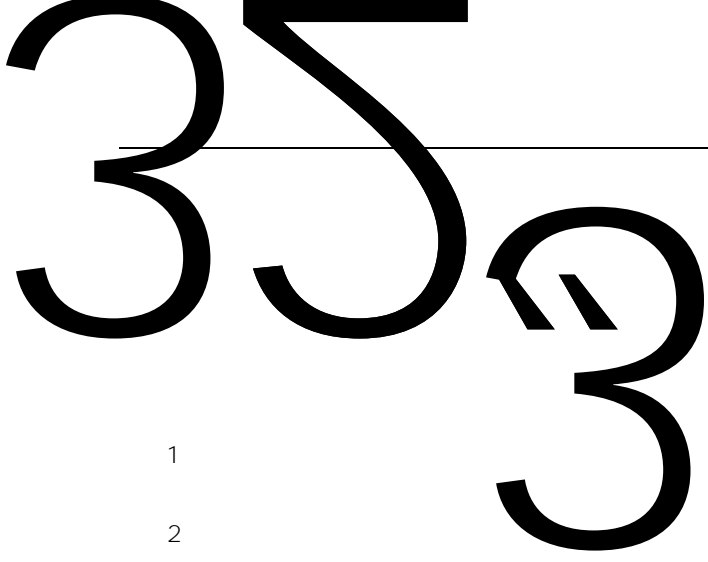

1

2

3

3.

4.

5.

1

2

3

16

1.

1

2



--

2



1

2

3

4

5

17

1

1

2

3

2

3

3

4

20

1

2

3

4

21

1

1.

2



--	--	--

24

25

1

2

5

26

1

2

3

4

5

27

1.

2

2

3

4

5

1

6

3

4

28

1.

1

2

3

4

2

1

2

3.

3

1

" "

2

3

4

1

2

1

30

1.

26 / 38 / 43.

2.

1

3.

31 /

()

1.

1

2

2

1

2

3

3

1

2

32

1

2

3

4

5



--	--	--

□

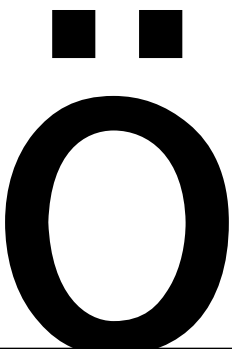



3



6

38

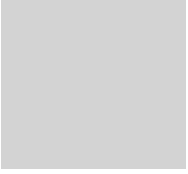



J

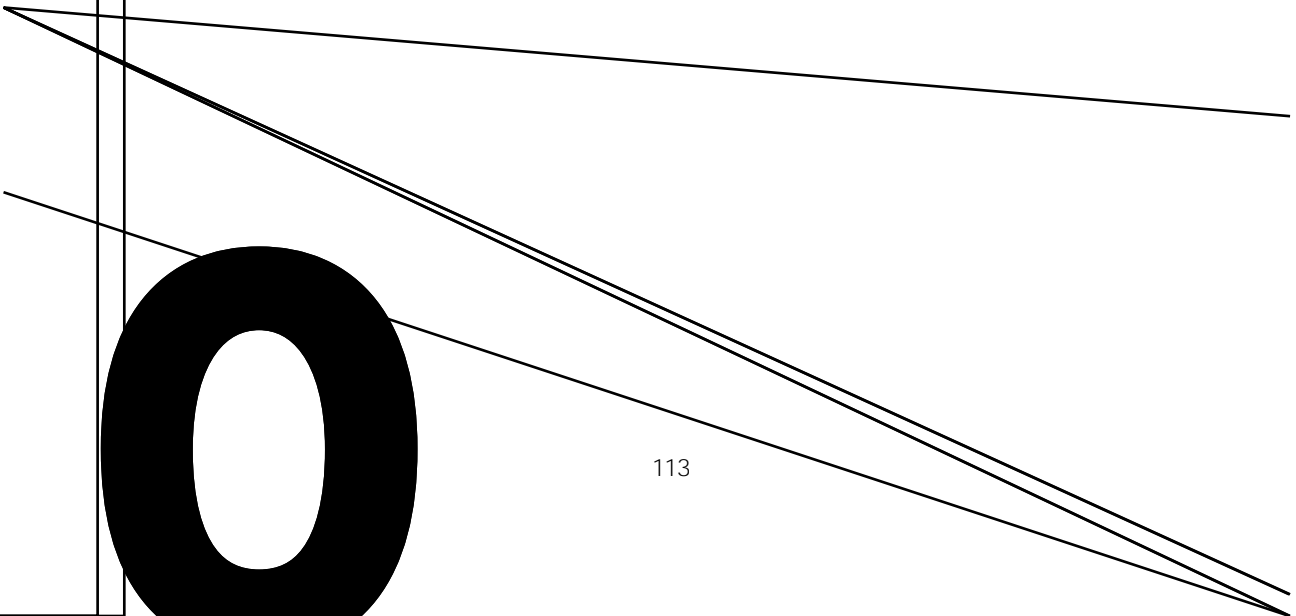



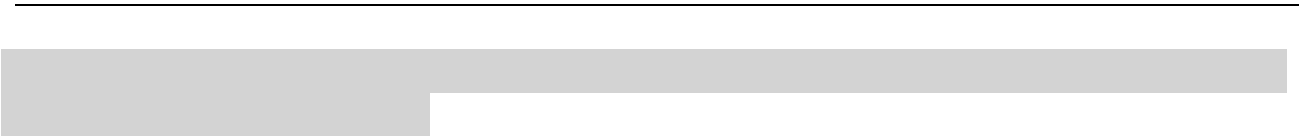

Q

U

1

z

z





[Redacted text block]

[Redacted text block]

[Redacted text block]

[Redacted text block]

[Redacted text block]



--	--	--

--	--



“





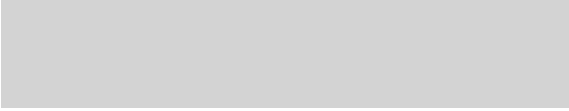

	/	/
--		
--		

6

	--	--	--	--
--	----	----	----	----

1

4

1

/

--	--	--	--	--	--

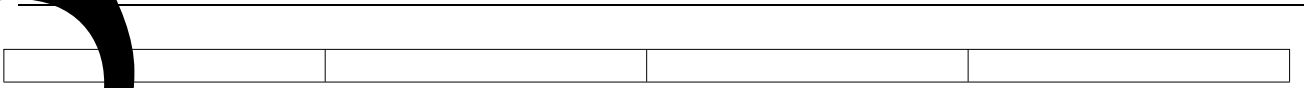
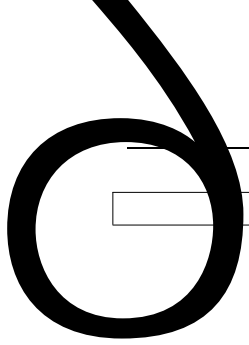

© 2000 Cisco Systems, Inc. All rights reserved. Cisco Confidential

1

Cisco

(c) 2000 Cisco Systems, Inc. All rights reserved.

f i

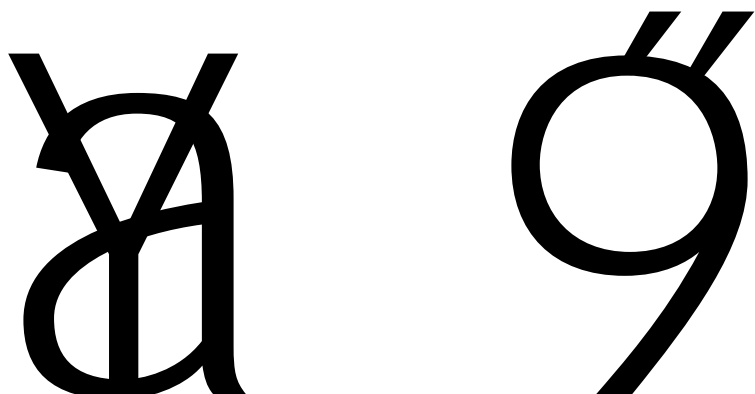

1

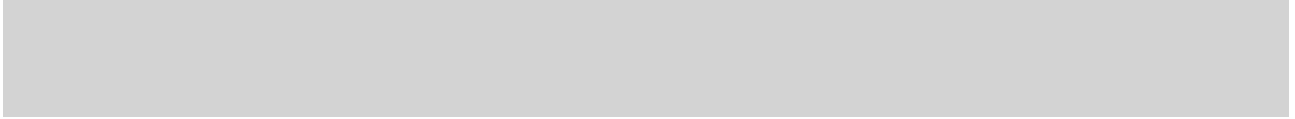

|



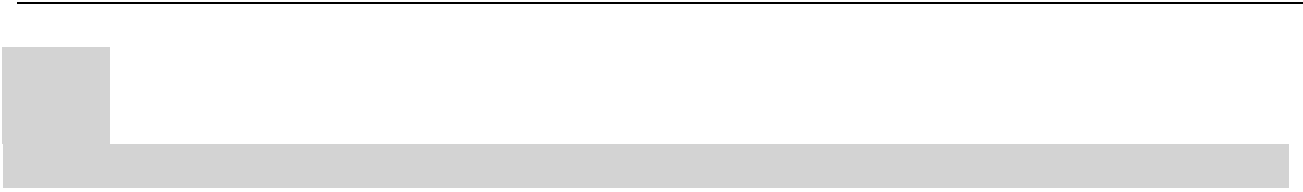



1 --

		/	/